

BTEL5000 / PTUL5000 Series

Precision very low differential pressure transmitters

FEATURES

- 1 to 10 mbar, 1 to 10 inH₂O differential pressure
- 1...6 V or 4...20 mA output
- Precision temperature compensated and calibrated
- Rugged aluminium housing
- Female 1/8" BSP and 1/8" NPT fittings

MEDIA COMPATIBILITY

Pressure inlet:

Non-corrosive, non-ionic working fluids such as air, dry gases and the like

Housing:

Aluminium, protection class IP 67 (according to DIN EN 60529, NEMA 6)¹



SPECIFICATIONS¹²

Maximum ratings

Supply voltage ¹¹	12...32 V
Output current	
BTEL/PTUL5...D1...	
Source	20 mA
Sink	10 mA
BTEL/PTUL5...D4...	30 mA
Temperature limits	
Storage	-40...100°C
Operating	-25...85°C
Compensated	0...50°C
Proof pressure ²	
BTEL/PTUL5...01D...	250 mbar / 100 "H ₂ O
BTEL/PTUL5...02D...	250 mbar / 100 "H ₂ O
all others	350 mbar / 150 "H ₂ O
Pressure at any port ³	
BTEL/PTUL5...01D...	500 mbar / 200 "H ₂ O
BTEL/PTUL5...02D...	500 mbar / 200 "H ₂ O
all others	750 mbar / 300 "H ₂ O

ELECTRICAL CONNECTION

1...6 V output version

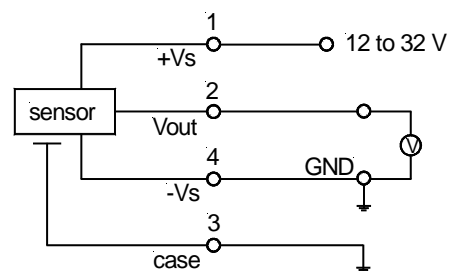

4...20 mA output version

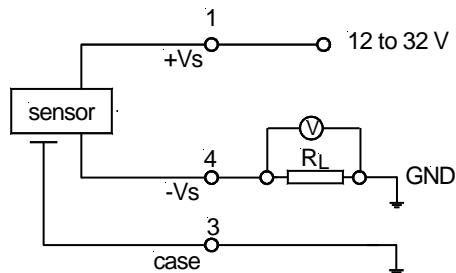

BTEL5000 / PTUL5000 Series

Precision very low differential pressure transmitters

COMMON PERFORMANCE CHARACTERISTICS⁹

Characteristics		Min.	Typ.	Max.	Unit
Position sensitivity			0.5		%FSO/g
Non-linearity and hysteresis ⁴			±0.1	±0.25	%FSO
Output noise (0 < f < 1 kHz)			0.04		
Long term stability ⁵	BTEL/PTUL5...01D...		±0.5		
	all others		±0.2		
Thermal effects (0 to 50°C) ⁶	Offset	BTEL5...01D...	±0.08	±0.16	%FSO/°C
		BTEL5...02D.../ PTUL5...01D...	±0.04	±0.10	
		all others	±0.02	±0.06	
	Span		±0.04	±0.08	
Response time (10 to 90 %)			1		ms

INDIVIDUAL PERFORMANCE CHARACTERISTICS⁹

1...6 V output versions ($V_S = 15\text{ V}$, $t_{amb} = 25^\circ\text{C}$, $R_L > 100\text{ k}\Omega$, com. mode pressure = 0)

Characteristics		Min.	Typ.	Max.	Unit
Zero pressure offset ⁷	BTEL/PTUL50...D1...	0.9	1.0	1.1	V
	BTEL/PTUL5P...D1...	3.4	3.5	3.6	
Full scale span ⁸	BTEL/PTUL50...D1...	4.9	5.0	5.1	
	BTEL/PTUL5P...D1...	2.4	2.5	2.6	
Full scale output			6.0		
Output impedance				50	Ω
Power supply rejection	Offset		0.05		%FSO/V
	Span		0.03		
Power consumption			60		mW

4...20 mA output versions ($V_S = 15\text{ V}$, $t_{amb} = 25^\circ\text{C}$, $R_L = 100\ \Omega$, com. mode pressure = 0)

Characteristics		Min.	Typ.	Max.	Unit
Zero pressure offset ⁷	BTEL/PTUL50...D4...	3.9	4.0	4.1	mA
	BTEL/PTUL5P...D4...	11.9	12.0	12.1	
Full scale span ⁸	BTEL/PTUL50...D4...	15.9	16.0	16.1	
	BTEL/PTUL5P...D4...	7.9	8.0	8.1	
Full scale output			20.0		
Output impedance				0.1	Ω
Power supply rejection	Offset		0.05		%FSO/V
	Span		0.03		
Power consumption ($I_L = 20\text{ mA}$)			260		mW

BTEL5000 / PTUL5000 Series

Precision very low differential pressure transmitters

LOAD LIMITATION

4...20 mA output version

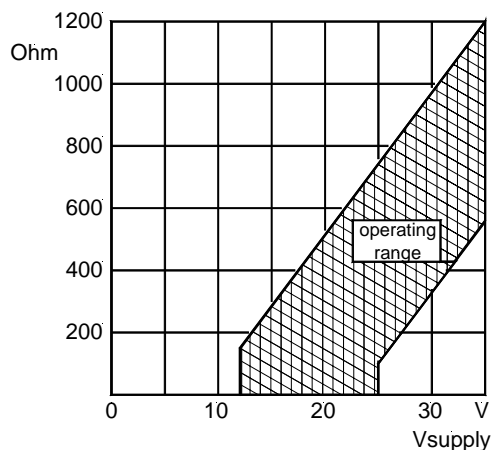

ELECTROMAGNETIC CAPABILITY¹⁰

	Test conditions	Criterion	Interference
Radiated, radio frequency electromagnetic field immunity (RFI)	EN61000-4-3: 10 V/m, 80 to 1000 MHz 80 % AMC (1 kHz)	A	<1 %FSO
Electrical fast transient / burst immunity (EFT)	EN61000-4-4: ±2 kV	B	<1 %FSO
Electrostatic discharge immunity test (ESD)	EN61000-4-2: ±4 kV, contact discharge ±8 kV, air discharge	B	<1 %FSO
Immunity to conducted disturbances induced by radio-frequency fields	EN61000-4-6: 0.15 to 80 MHz 10 V, 80 % AMC (1 kHz)	A	<1 %FSO

Specification notes:

1. IP 67 protection for BTEL/PTUL5...A is given with locked connector only.
2. Proof pressure is the maximum pressure which may be applied without causing damage to the sensing element.
3. This is the highest pressure which can be applied to any port at any time. At the same time the differential pressure between the ports H and L must not exceed the maximum proof pressure.
4. Non-linearity refers to the **Best Straight Line** fit measured for offset, full scale span and 1/2 full scale span.
5. Long term stability is the change in output after one year or 1 million pressure cycles.
6. Thermal effects tested and guaranteed from 0...50 °C relative to 25°. All specifications shown are relative to 25°C.
7. Calibrated after minimum 3 minutes warm-up time.
8. Full scale span is the algebraic difference between the positive full scale output and zero pressure offset.
9. Higher pressure applied to port H.
10. Test are in accordance with EN 61000-6-2.
11. The minimum supply voltage is directly proportional to the load resistance seen by the transmitter. For more details see the load limitation diagram.
12. CE-labelling is in accordance with 2004/108/EC.

BTEL5000 / PTUL5000 Series

Precision very low differential pressure transmitters

OUTLINE DRAWING

Connector version

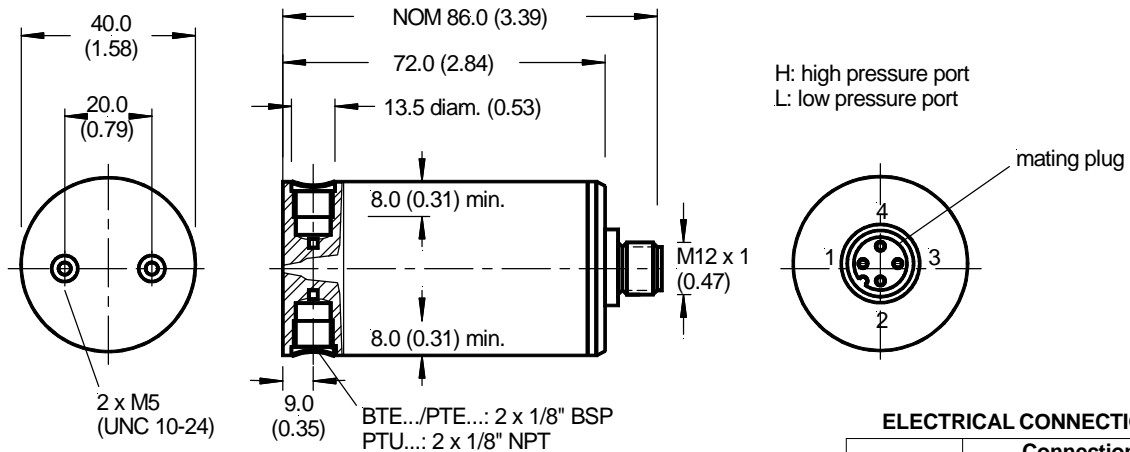

mass: typ. 170 g
dimensions in mm (inches)

ELECTRICAL CONNECTION

Pin	Connection	
	1...6 V output	4...20 mA output
1	+Vs	+Vs
2	Vout	NC
3	case	case
4	-Vs	-Vs

Cable version

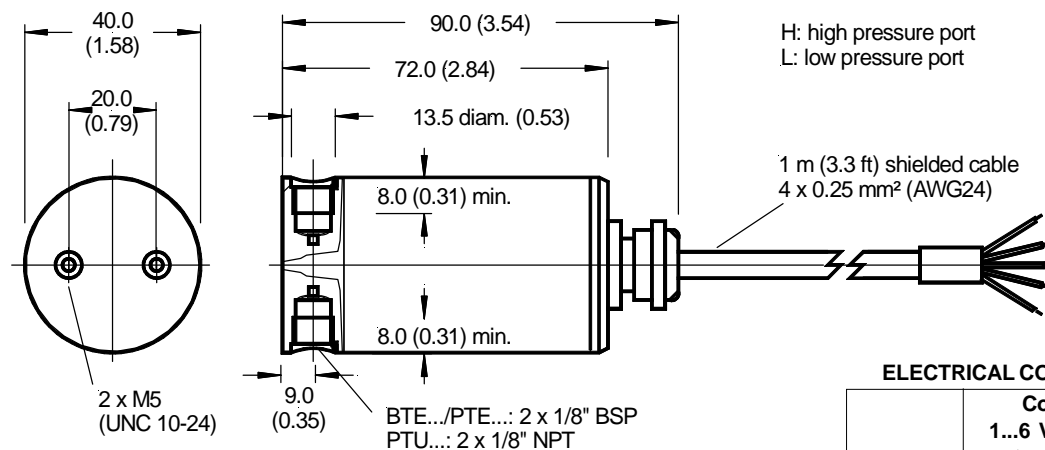

mass: typ. 220 g
dimensions in mm (inches)

ELECTRICAL CONNECTION

	Connection	
	1...6 V output	4...20 mA output
bare	case/shield	case/shield
brown	+Vs	+Vs
white	NC	NC
green	Vout	NC
yellow	-Vs	-Vs

BTEL5000 / PTUL5000 Series

Precision very low differential pressure transmitters

RECOMMENDED CABLE/CONNECTOR ACCESSORY

for connector version

Order number **ZK000101**, other cable lengths on special request

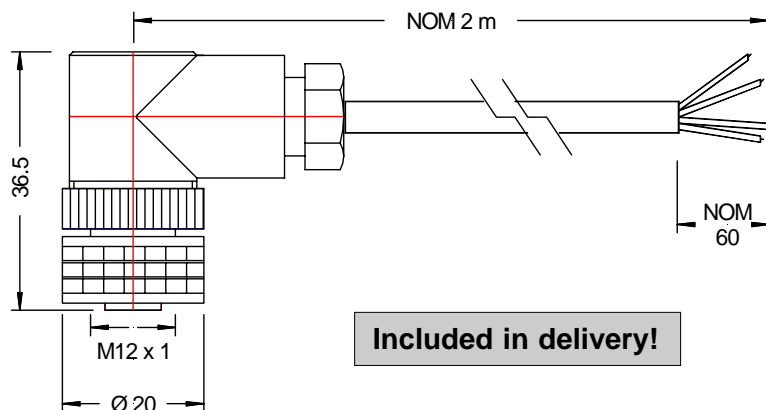

PIN CONNECTION

Pin	Flying lead end
1	brown
2	green
3	white + shield
4	yellow

dimensions in mm

ORDERING INFORMATION

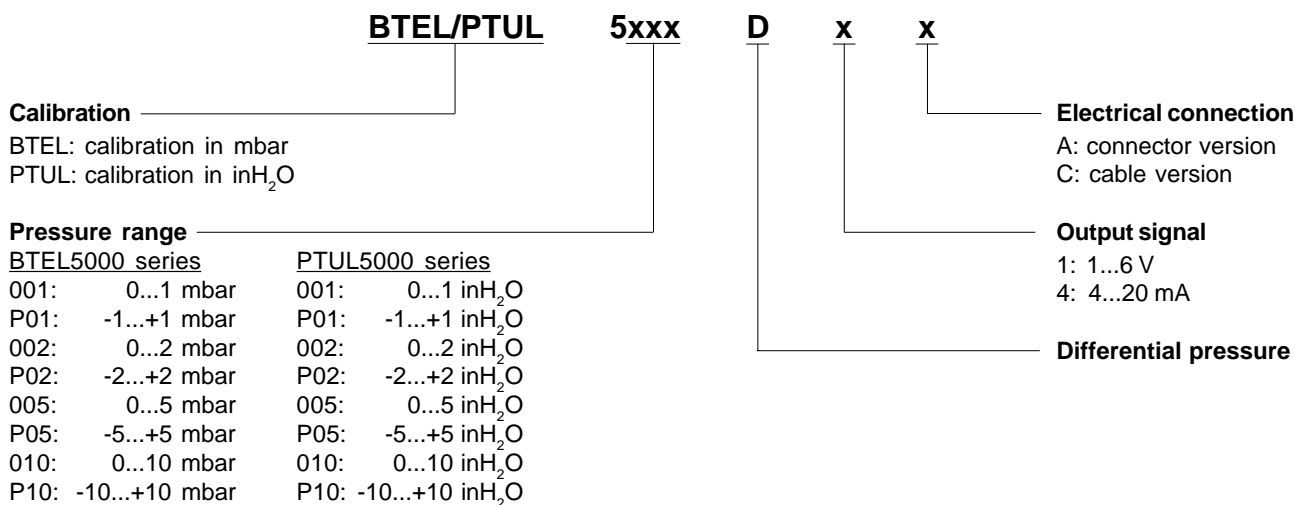

Note: 0...1 mbar devices not available with 1...6 V output signal

Other pressure ranges and options are widely available. Please contact First Sensor.

First Sensor reserves the right to make changes to any products herein. First Sensor does not assume any liability arising out of the application or use of any product or circuit described herein, neither does it convey any license under its patent rights nor the rights of others.